

Ansichten

Rahmenteile:

T-SB F3003-1 SKG MV

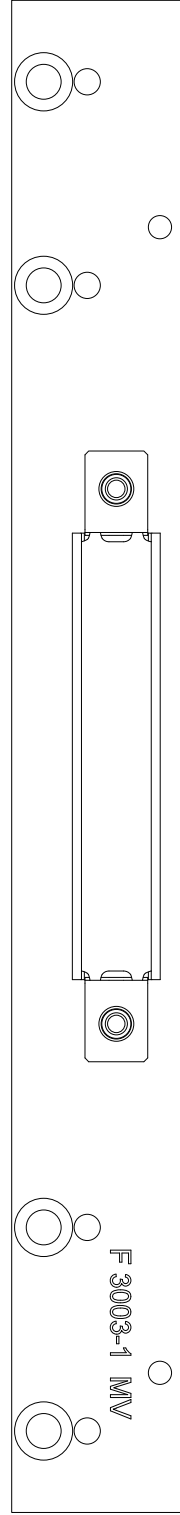
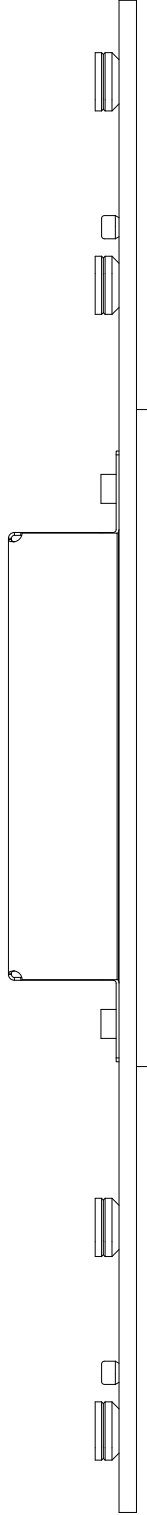

Fräsmaße

Rahmenteile: T-SB F3003-1 SKG MV

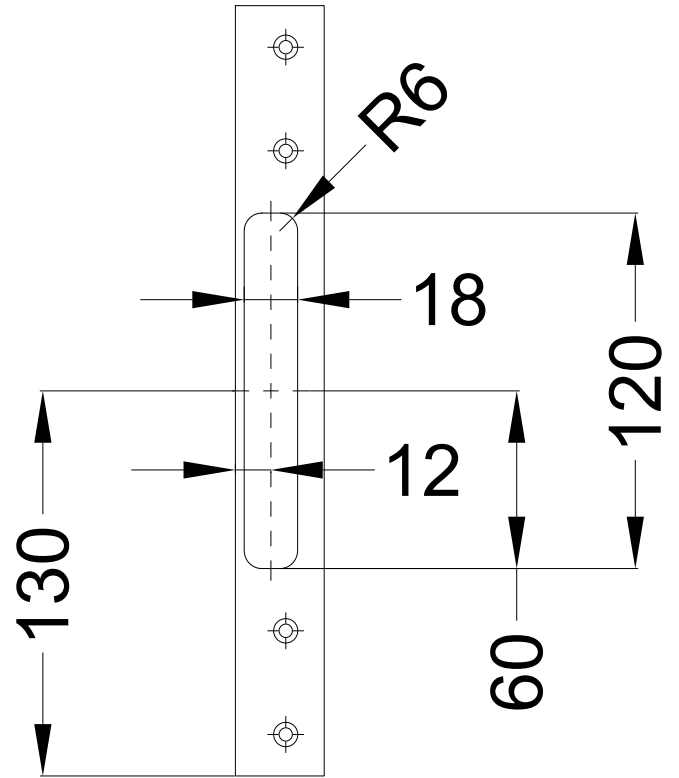
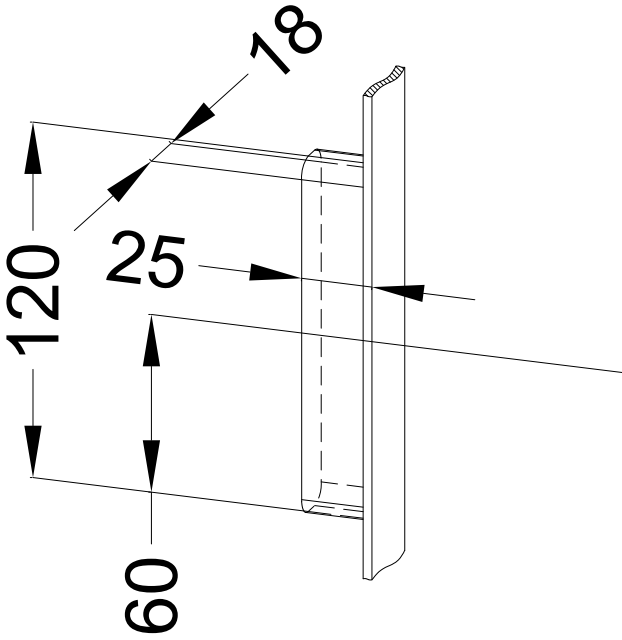

Allgemeine Vermaung

Frsmae

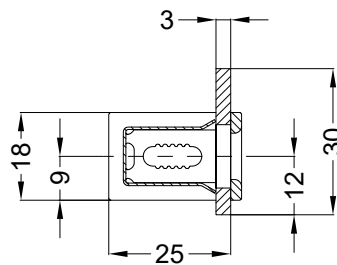
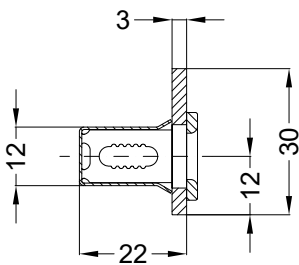

Situation
Schwenkriegel

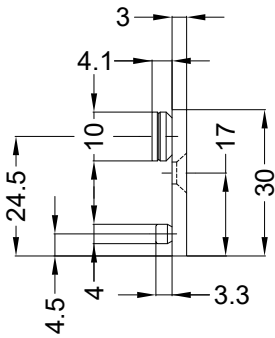

Lage
Schlieblech

