

Perspektive
Schloss:

T-FG24126 .../30 92/... M2

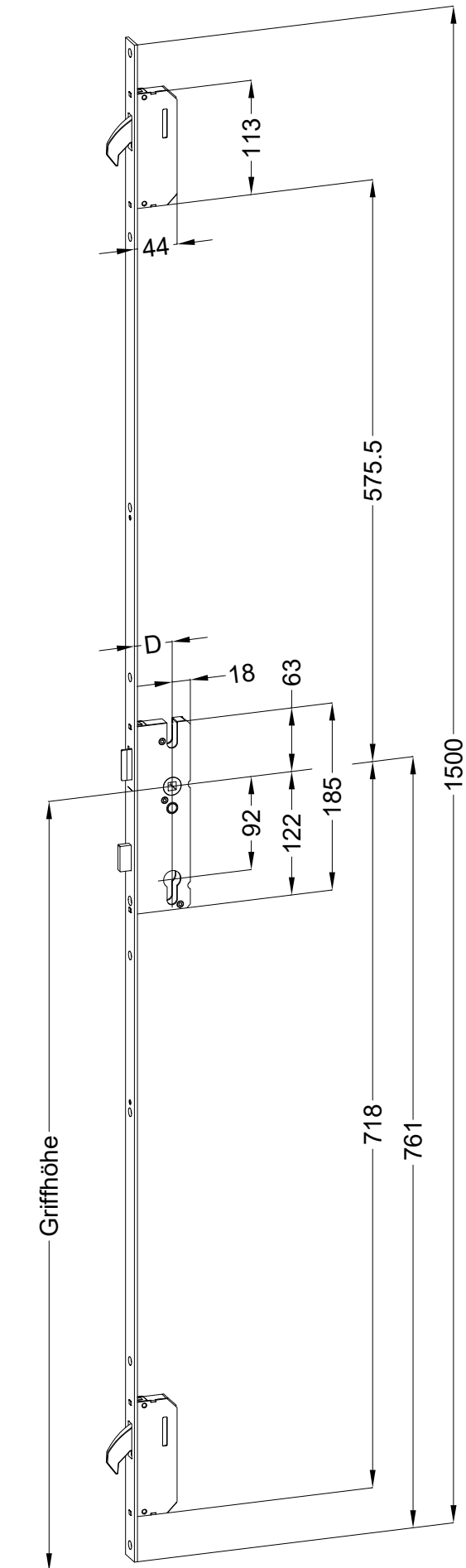

Technische Änderungen vorbehalten!

Schraublage
Schloss:

T-FG24126 .../30 92/... M2

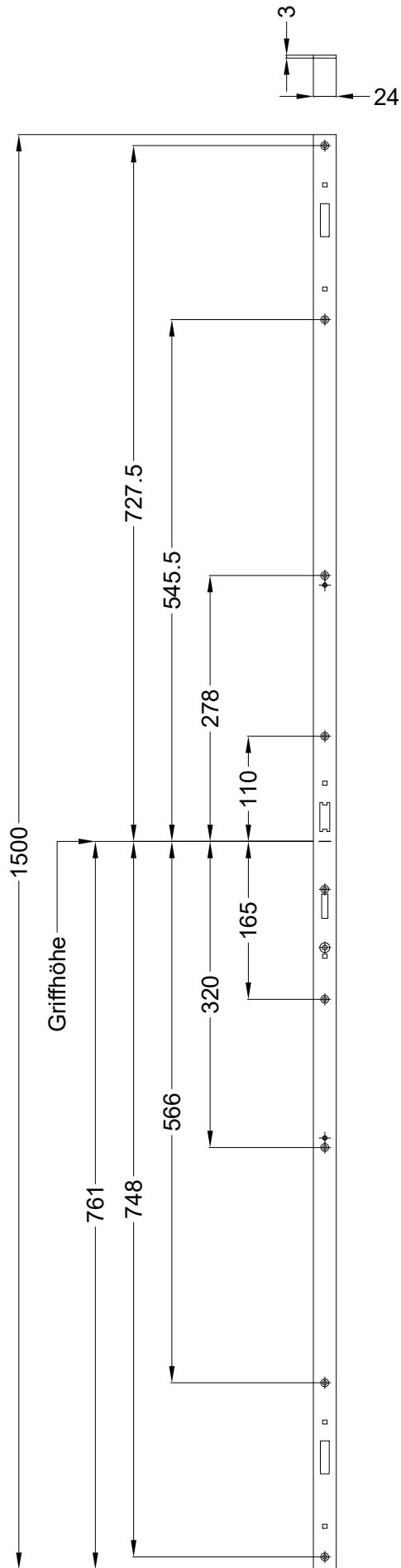

Ansichten
Schloss:

T-FG24126 .../30 92/... M2

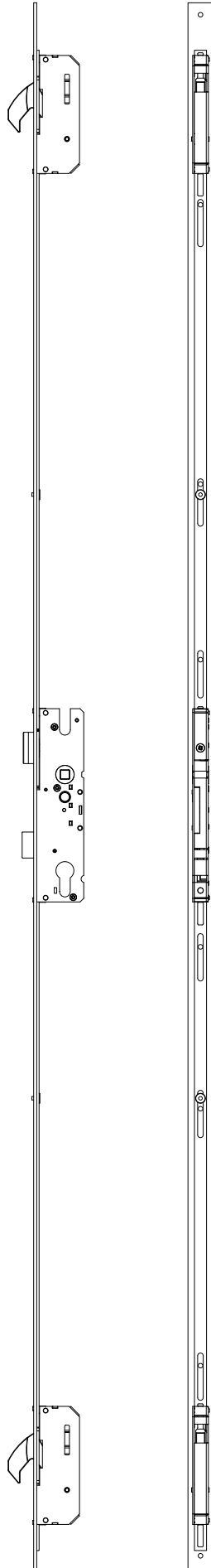

Technische Änderungen vorbehalten!

Allgemeine Vermaung

Frsmae

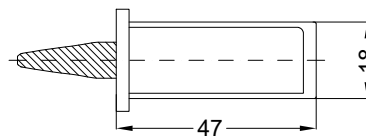
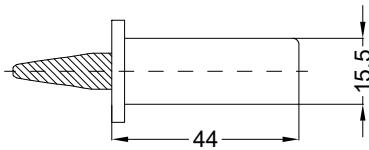

Situation
 Schwenkriegel
 TM6 Y2K

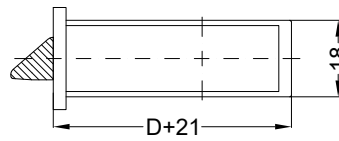
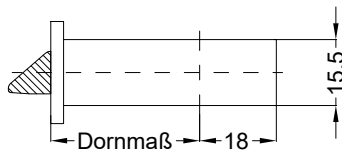

Situation
 Falle
 SK TT

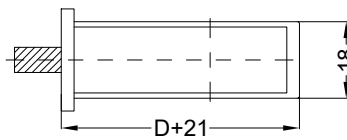
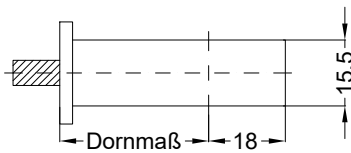

Situation
 Riegel
 SK TT

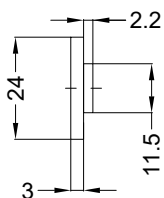

Lage
 Schloss

Empfohlene Fräsung

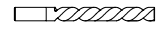

Ø 12

