

Towel rail

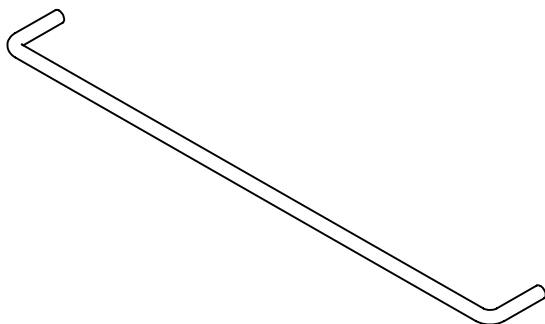
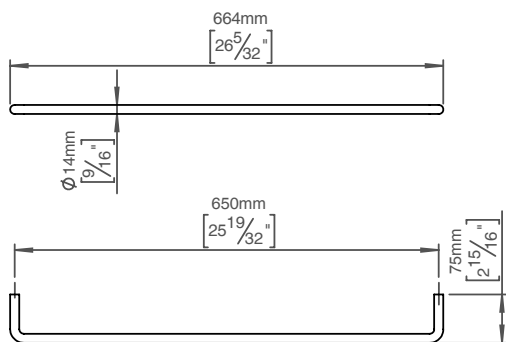

Knud Holscher collection

Product Ø14x650mm, bush, satin finish.

Tender text Knud Holscher collection, towel rail, 14x650mm, bush. Manufactured in the highest quality marine grade, AISI 316 stainless steel, protecting against high levels of corrosion. 20-year warranty.

Product specification Dimensions: 664x14x75mm
Diameter: Ø14mm
Material: stainless steel AISI 316
Surface finish: satin grain 320, crafted by hand
[20-year warranty \(5 years for coated items\)](#)

Available finishes

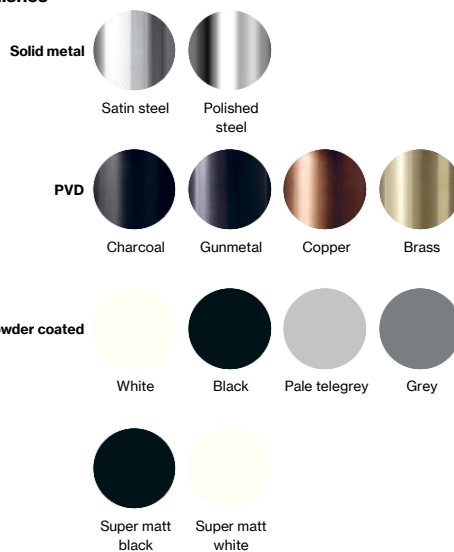

Spare parts/ accessories P 170 - Bush and grub screw
P 451 - Screw and plug

Mounting <https://dline.com/mounting-instructions/>

Product care

d line products are produced in the highest quality marine grade AISI 316 stainless steel. To sustain the unique d line finish please follow the below instructions:

- Wash down the surfaces using soapy water or mild detergent
- Always thoroughly rinse off with clean water
- To complete the cleaning procedure dry/polish the surface with a soft dry cloth

Please do not use scouring powder, steel wool, chloride based detergents or other aggressive cleaning products as these may damage the surface.

If spots or corrosion appear on the surface it is not due to the stainless steel quality, but to impurities in the environment, aggressive conditions or improper or insufficient cleaning.