



366006 - Zwischenlage Getriebe DM-6 mm 1,5 mm Perlhellgrau RAL 9022

Technische Zeichnung



				No
Perlhellgrau RAL 9022	Zwischenlage	1,5	50	366006

Montage Zwischenlage

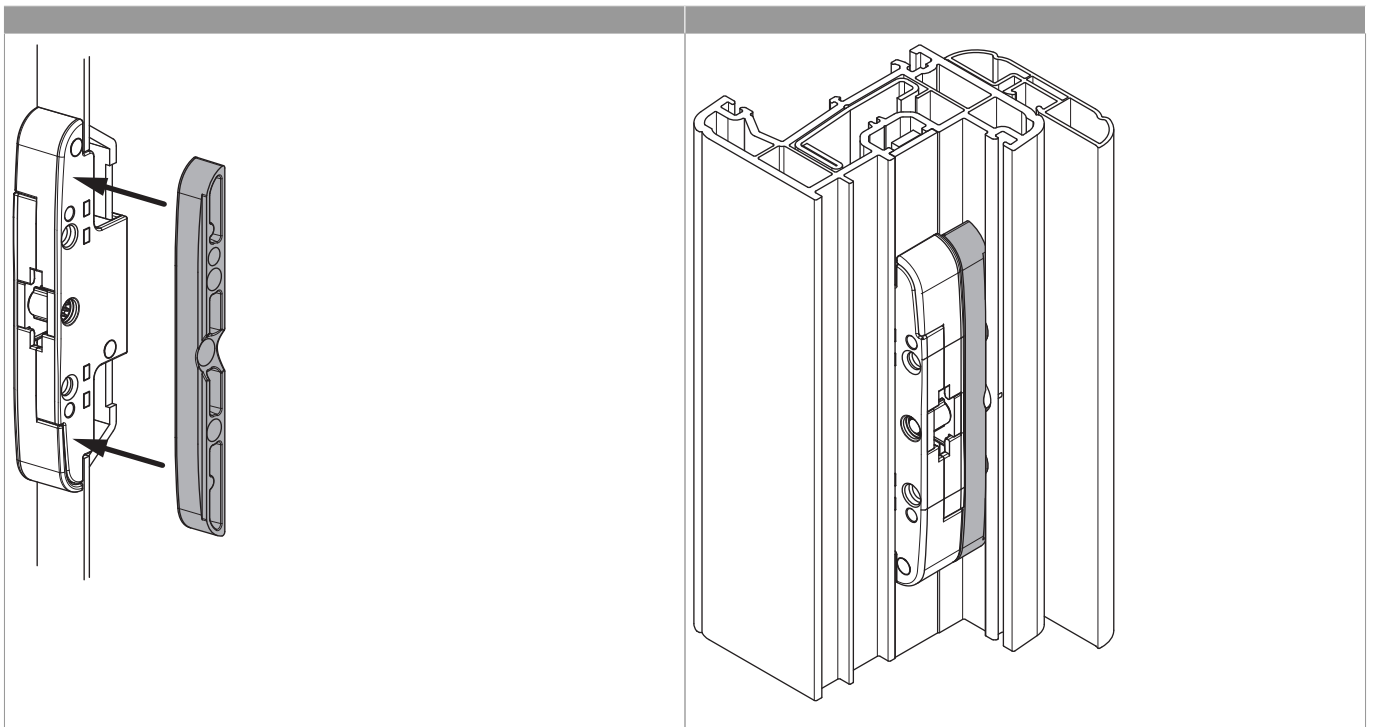



366006 - Zwischenlage Getriebe DM-6 mm 1,5 mm
Perlhellgrau RAL 9022

